

**Specificalton**

NO.				
<b>Output</b>	Model	<b>KS150DU-1201000</b>		
	DC Voltage	12V		
	Rated current	10A		
	Output current range	0~10.0A		
	Rated power(Max)	120W		
	Ripple and noise(Max)	120mVp-p		
	Voltage Tolerance Note.3	±5%		
	Line Regulation Note.4	±1%		
	Load Regulation	±5%		
Set up, RiseTime Note.6	1000ms, 30ms, 50ms/230VAC    1500ms, 30ms, 15ms/115VAC (full load)			
<b>input</b>	Voltage Range Note.7	85~264VAC		
	Frequency Range	47~63Hz		
	Efficiency (Typical values)	88.0%		
	PFC	0.9		
	AC current	MAX 2.5A/115VAC; 230VAC		
	Inrush current (Max)	35A/115VAC    65A/230VAC		
	Leakage Current (Max)	0.75mA/240VAC		
<b>Protection</b>	Short circuit protection	The power supply shall not be damaged by short between DC output and DC ground The power supply shall automatically restart when short to ground are removed		
	Overvoltage	110%~140% Rated output voltage Protection type: Diode clamp, output short circuit		
	Overcurrent	Protection type: Hiccup Mode; 13A-16A overcurrent protection at 100-240VAC Input voltage		
<b>Environment</b>	Operating temperature	-30~+45℃		
	Operating Humidity	20~90%RH, (Non-condensing)		
	Storage temperature, Hum	-40~+85℃, 10~95%RH		
	TEMP.Coefficient	±0.03%/℃ (0~50℃)		
	Shock	10~500Hz, 2G 10Minute/Period, Period:60minute,along X、Y、Z		
<b>Safety Standards electromagn etic compatibility</b>	Safety Standards	KC K60950-1, RoHS, UL62368, UL60950-1, TUV EN62368-1, AS/NZS 62368.1		
	Pressure	I/P-O/P: 4242VDC, I/P-FG: 2121VDC		
	Insulation resistance	I/P-O/P, I/P-FG: 100M Ohms/500VDC/25℃/70%RH		
	EMC Emission	<b>Parameter</b>	<b>Standard</b>	<b>Test Level/Note</b>
		Conducted emission	EN55032(CISPR32),FCC PART 15/CISPR22 CAN ICES-3(B)/NMB-3(B),CNS13438,GB17625.1	Class B
		Radiated emission	EN55032(CISPR32),FCC PART 15/CISPR22 CAN ICES-3(B)/NMB-3(B),CNS13438,GB17625.1	Class B
		Harmonic current	EN61000-3-2,GB9254	Class A
		Voltage flicker	EN61000-3-3	.....
	EMC immunity	<b>Parameter</b>	<b>Standard</b>	<b>Test Level/Note</b>
		ESD	EN61000-4-2	Level 3, 8KV air; Level 2, 4KV contact
		RF field susceptibility	EN61000-4-3	Level 2,3V/m
		EFT bursts	EN61000-4-4	Level 2,1KV
		Surge susceptibility	EN61000-4-5	Level 4,2KV/Line-line,4KV/Line-FG
		Conducted susceptibility	EN61000-4-6	Level 2,3V
		Magnetic field immunity	EN61000-4-8	Level 2,3A/m
Voltage dips, interruption		EN61000-4-11	>95% dip 0.5 periods,30% dip 25 periods,	
<b>Other</b>	MTBF	≥50Khrs MIL-HDBK-217F(25℃)		
	Size	173*72*43mm(L*W*H)		
	Package	20PCS/CARTON		
	DC Plug	5.5*2.5*11mm		
<b>Note</b>	<ol style="list-style-type: none"> <li>1. Unless otherwise specified, all specifications are measured at 230VAC, rated load, and 25℃ 70% RH.</li> <li>2. DC voltage measurement method: measure at the socket terminal point under 50% load condition.</li> <li>3. Ripple and noise measurement method: use a 12" twisted pair cable, and the terminal should be connected with 0.1uf and 47uf capacitors in parallel, and measure at 20MHz bandwidth.</li> <li>4. Accuracy: Includes setting error, linear adjustment rate and load adjustment rate.</li> <li>5. Linear adjustment rate measurement method: from low voltage to high voltage test under rated load.</li> <li>6. Load regulation measurement method: 10%-100% from the rated load.</li> </ol>			

**KSPOME 120W AC DC ADAPTER Universal Dekstop Power Adapter**

■ 减额曲线

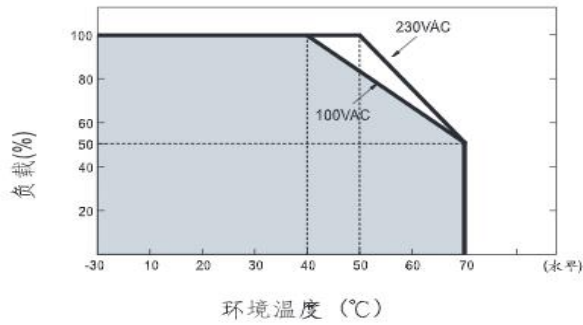

■ 静态特性曲线

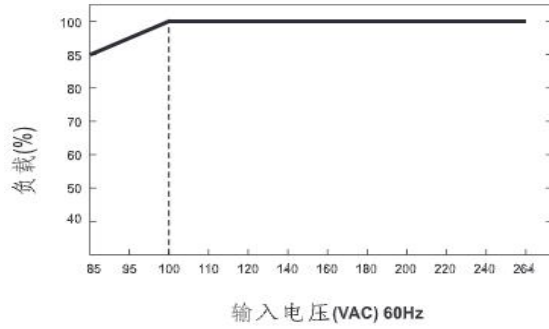

■ 机构尺寸

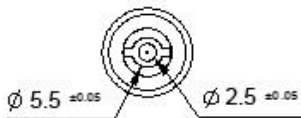
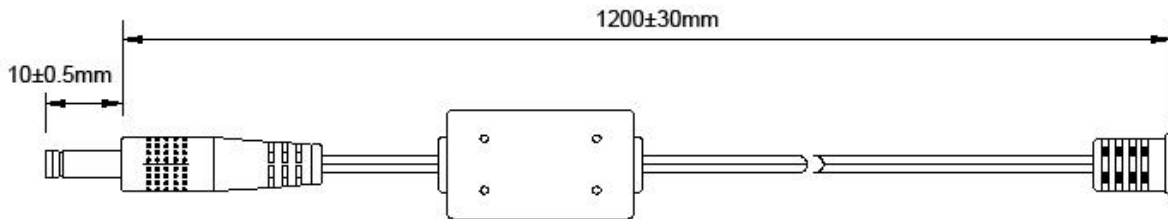
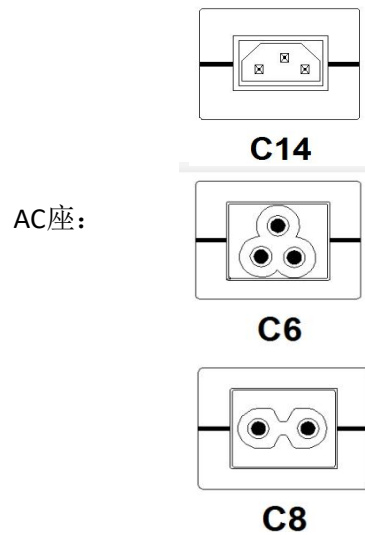
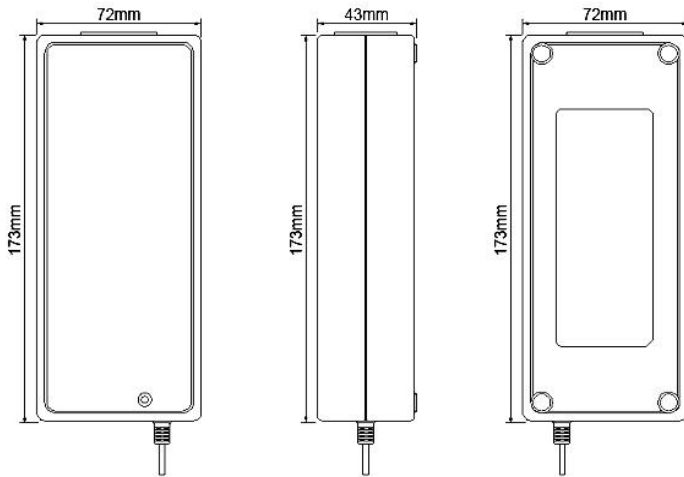

■ 装箱信息

重量/weight: 0.58kg/PCS (not including AC cable)  
 外箱/outer package: 50\*42\*17CM  
 包装/package: 20PCS/CARTON



极性: 内正外负  
 Polarity: Center Positive

■ 输入插头线

中国/CHINA

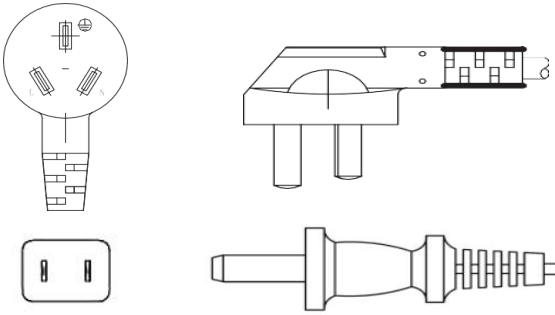

美国/NORTH AMERICA

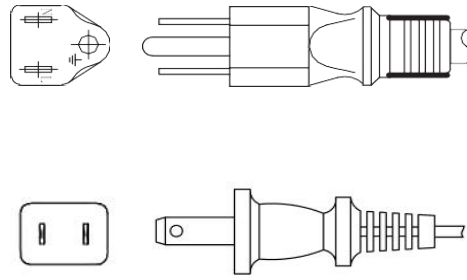

欧洲/EUROPE

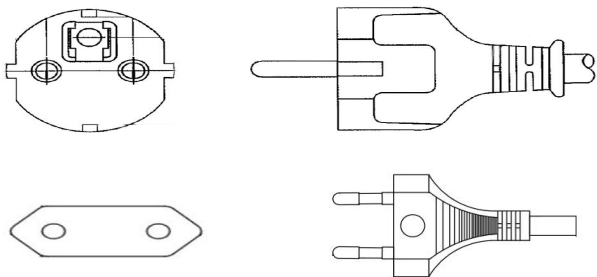

澳大利亚/AUSTRALIA

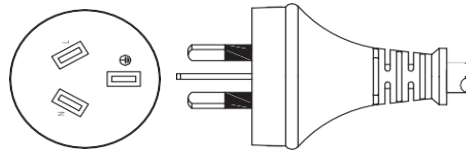

英国/UNITED KINGDOM

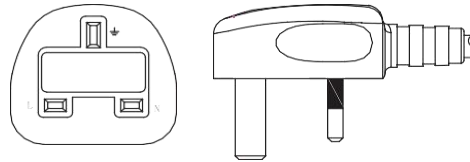

巴西/BRAZIL

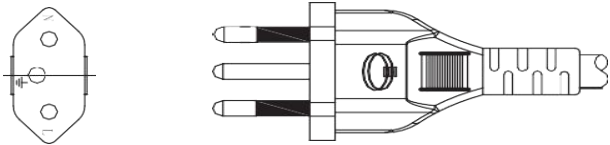

南非/SOUTH AFRICA

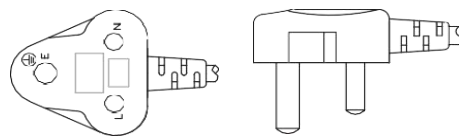

韩国/SOUTH KOREA

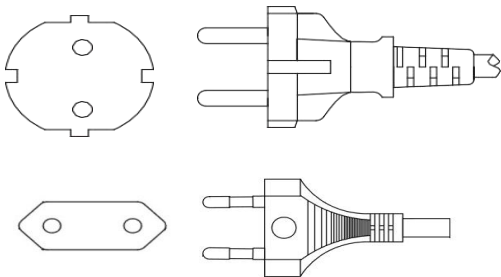

日本/JAPAN

